

ITEM NO.	P/N	Description	QTY.
1	BPSQ	BACKPLATE	2
2	HKSQ-2.5	Neck	2
3	CARD-58	LOCK	2
4	GLRT-22	GLASS	3
5	TU12-6	TUBE	4

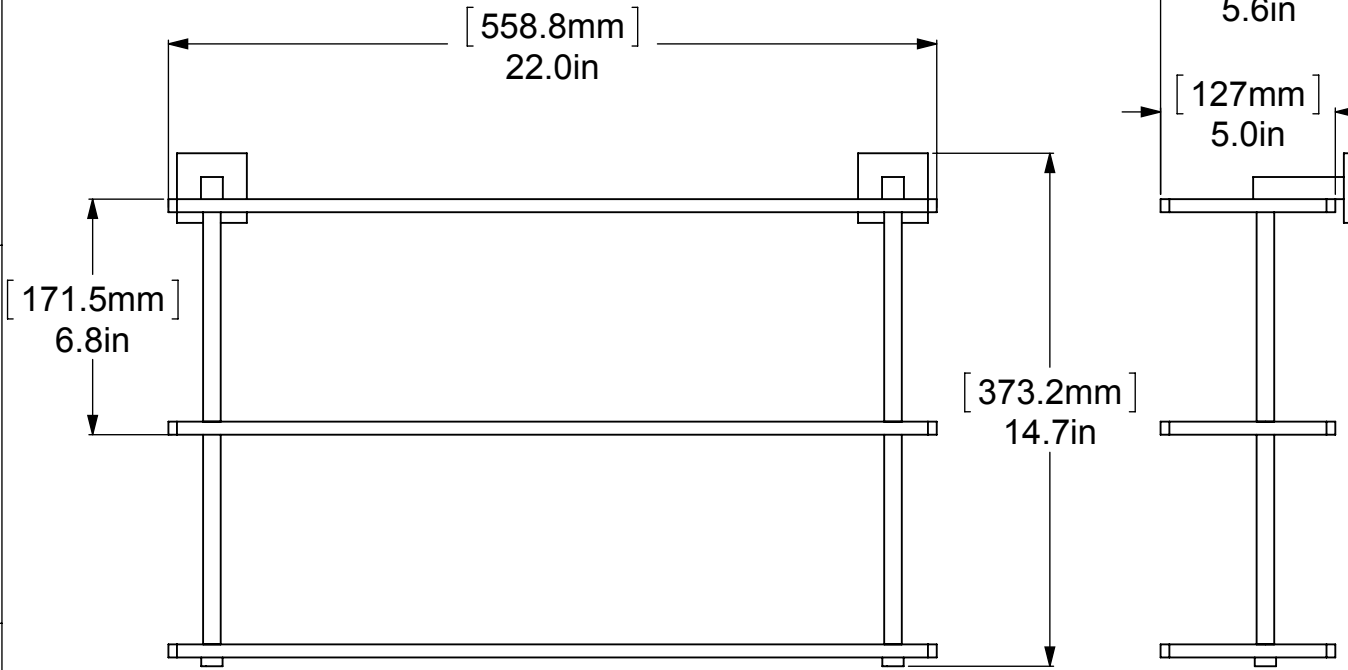
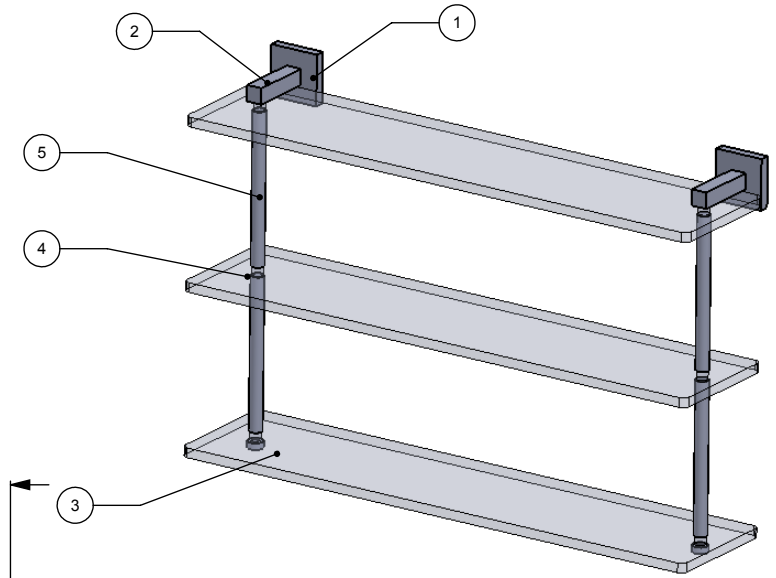

UNLESS OTHERWISE STATED

.X	±.3mm
.XX	±.15mm
.XXX	±.008mm

COPYRIGHT © Allied Brass 2016

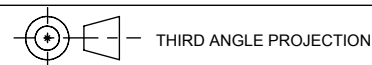

DRAWN	6/10/2016	I.M
CHECKED	6/10/2016	P.D
APPROVED	6/10/2016	R.A

MATERIAL:	BRASS
DESCRIPTION:	SHELF



FINISH	TBD
QUANTITY	TBD
DRAWING No.	REV
MT-5-22	0
SCALE	1:2.5
SHEET: 01	A4